

**Product Profile**

Part number	1808-1062
Article name	Adapter for tubes . 24x 1.5 ml or 15x 0.5 ml
Category	Conical shape / tubes
CO   Customs tariff code	DE   8479 90 70

**Specifications**

Ideal fit for*	
Material / Color	Aluminum anodized
Temperature range	-20 to 100 °C
Compatible with	QInstruments Devices with Art No 1808-xxx (All instruments with three point connection)
Mounting material	3x Cylinder screw (BN20146 M3x6-A2, lower head)   3x Torx screwdriver TX8
Adapter dimensions	see drawing
Weight	374 g   13.19 oz
Recommended max rpm	The maximum speed depends on a set of parameters like used device, liquid volume, height of labware, ... A general applicable value cannot be specified. Please refer to the operation manual of your device for additional information.

\* Latest information and possibly additional adapters are available on request: <https://www.qinstruments.com/contact/>

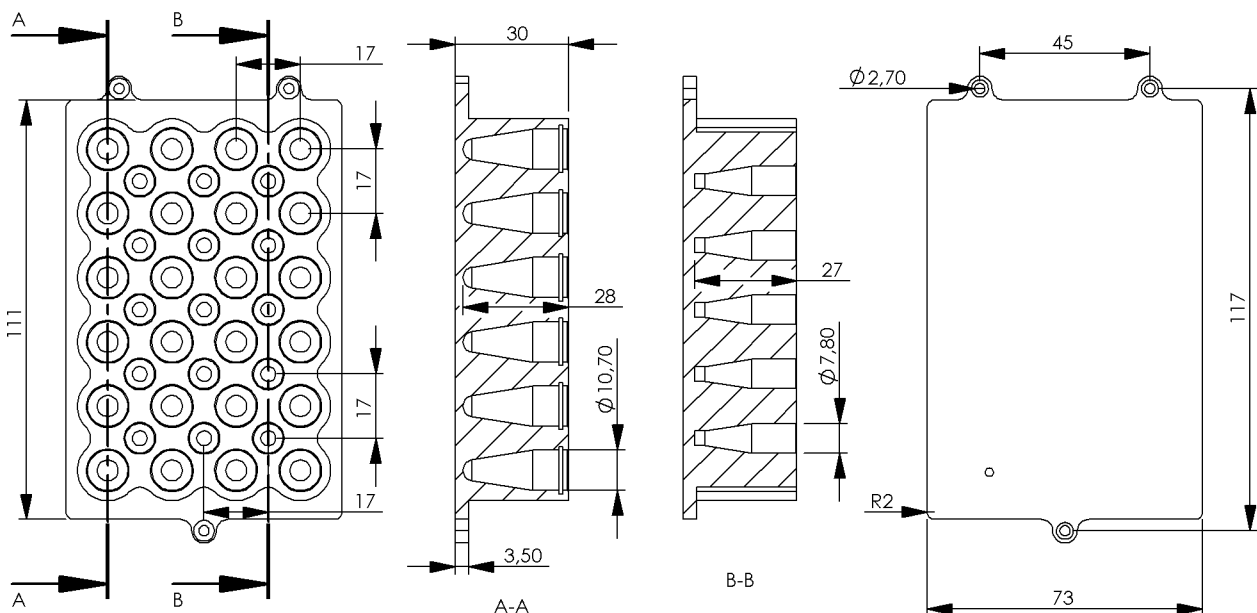
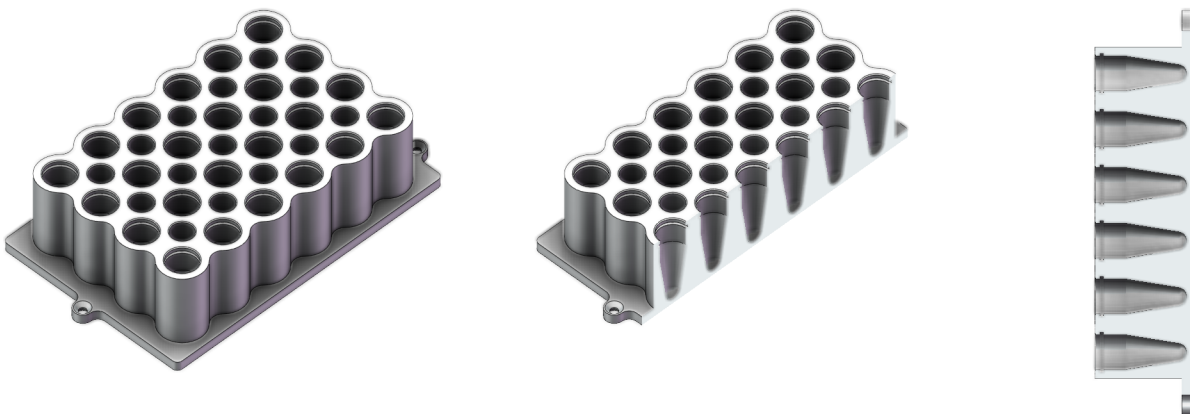

TECHNICAL SPECIFICATIONS ARE SUBJECT TO CHANGE WITHOUT NOTICE!